

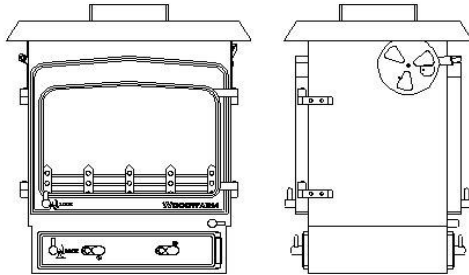

SPECIFICATION SHEET

DOUBLE SIDED FIREVIEW 6kw

Single Depth Flat Top



Single Depth Low Canopy

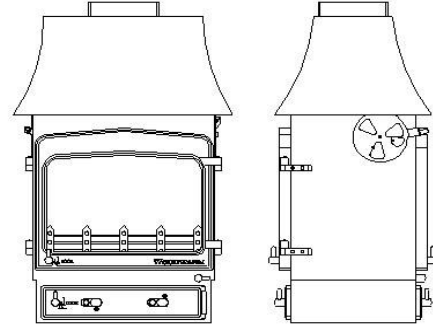

Double Depth Flat Top

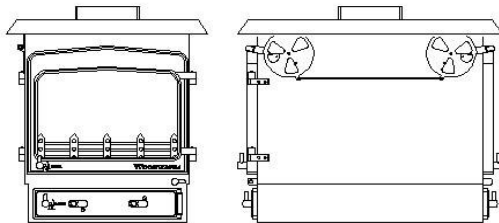

Double Depth Low Canopy

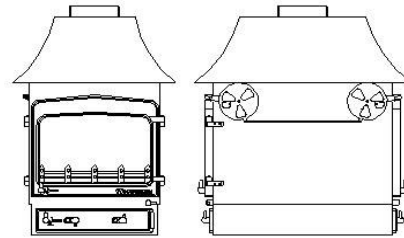

Dimensions (mm)

	Overall Height	Overall Width	Overall Depth	Flue Outlet Size
Single Depth Flat Top	613	555	436	178
Single Depth Low Canopy	830	564	415	178
Double Depth Flat Top	613	555	752	178
Double Depth Low Canopy	830	594	790	178

Maximum Log Length	Single Depth - 360
	Double Depth - 520

The standard finish for the above stove is metallic black, although the following finishes are also available from the factory:
 Rich Brown Metallic, Honey Glow Brown, Blue Metallic and Forest Green.
 (Ask your Dealer for a colour chart).

Accessories available are as follows:

- 50mm legs,
- 100mm legs,
- 200 mm high plinth,
- 200mm high pedestal.